

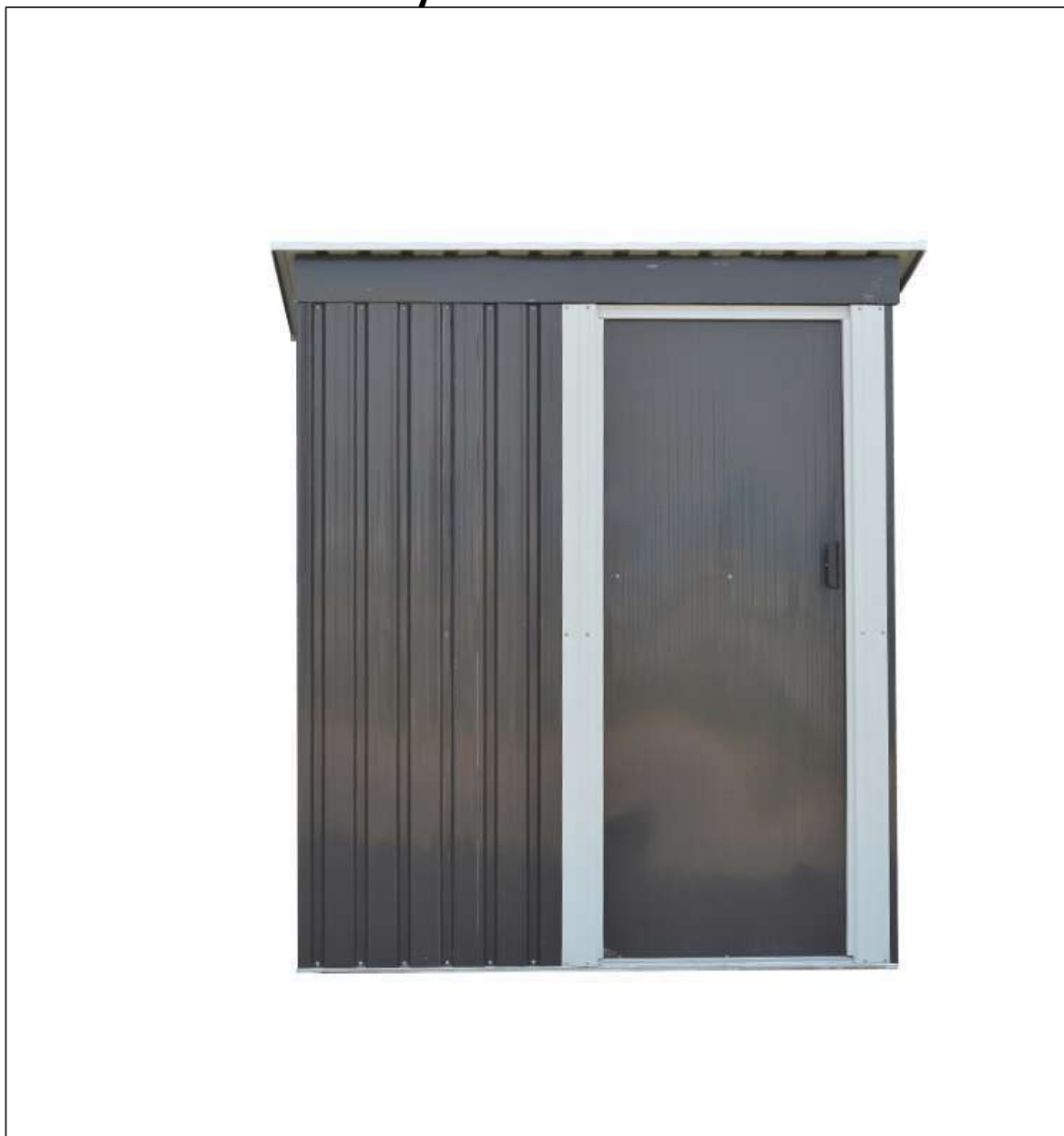

Kovový záhradný domček na náradie 164x89x182 cm Perth

Č. výrobku: 47095



Pred prvým použitím si dôkladne prečítajte návod na obsluhu a bezpečnostné pokyny!

**DEMA-VERTRIEBS GMBH, IM TOBEL 4, 74547 ÜBRIGSHAUSEN
WWW.DEMA-VERTRIEB.COM**

© DEMA VERTRIEBS-GMBH

Obsah

1 Bezpečnostné pokyny	3
1-1 Určené využitie	3
2 Technické údaje	3
3 Montáž	3
3-1 Krok 1	4
3-2 Krok 2	5
3-3 Krok 3	6
3-4 Krok 4	7
3-5 Krok 5	8
3-6 Krok 6	9
3-7 Krok 7	10
3-8 Krok 8	11
3-9 Krok 9	12
3-10 Krok 10	13
3-11 Krok 11	14
4 Údržba	14
5 Zoznam dielov	15

1 Bezpečnostné pokyny

- Zmeny, slúžiace technickému pokroku môže výrobca zaviesť bez predchádzajúceho upozornenia a nemusia byť zohľadnené v tomto návode.
- Pred použitím skontrolujte kôľnu na úplnosť a funkčnosť!
- Nikdy nepoužívajte pokazenú, alebo nefunkčnú kôľnu! Kontaktujte výrobcu, alebo si dajte kôľnu prezrieť kvalifikovanému mechanikovi.
- Stále pracujte sústredene a opatrne!
- Nikdy nevystupujte na strechu!
- Nikdy nemontujte kôľnu počas silného vetra, alebo búrky!
- Pri montáži v žiadnom prípade nepoužite neprimeranú silu!
- Pri montáži používajte osobné ochranné pracovné prostriedky (ochranné rukavice, pracovnú obuv, atď.).
- V kôľni nikdy neprechovávajte nebezpečné látky, ľudí, ani zvieratá!
- Pre vlastnú bezpečnosť používajte pri montáži rukavice!
- Obaly (fólie, plastové vrecia, styropor, atď.) odkladajte len na miesta, nedostupné deťom, hlavne kojencom! Obaly môžu predstavovať skryté ohrozenie (napr. nebezpečenstvo udusenía).

1-1 Určené využitie

- Záhradný dom je vhodný pre uskladnenie záhradného náradia.
- Záhradný dom nie je vhodný pre prechovávanie nebezpečných látok, osôb, ani zvierat!

2 Technické údaje

Kompletné rozmery	164 x 89 x 182 cm
Hmotnosť	28 kg

3 Montáž

Na montáž záhradného domčeka potrebujete:

- Minimálne dve osoby
- Skrutkovač, alebo uťahovačka s nástavcami
- Rebrík
- Rukavice
- Meter
- Vodováha
- Vidlicový kľúč
- Uholník

- Ako pomôcku pri montáži použite nasledovné náčrty.
- Kôľnu montujte za slnečného počasia a bezvetria.
- Naplánujte si pre montáž dostatok času.
- Pred montážou odstráňte z jednotlivých komponentov ochrannú fóliu.

3-1 Krok 1

Spojte skrutkami (F1) základové lišty (1) - (4).

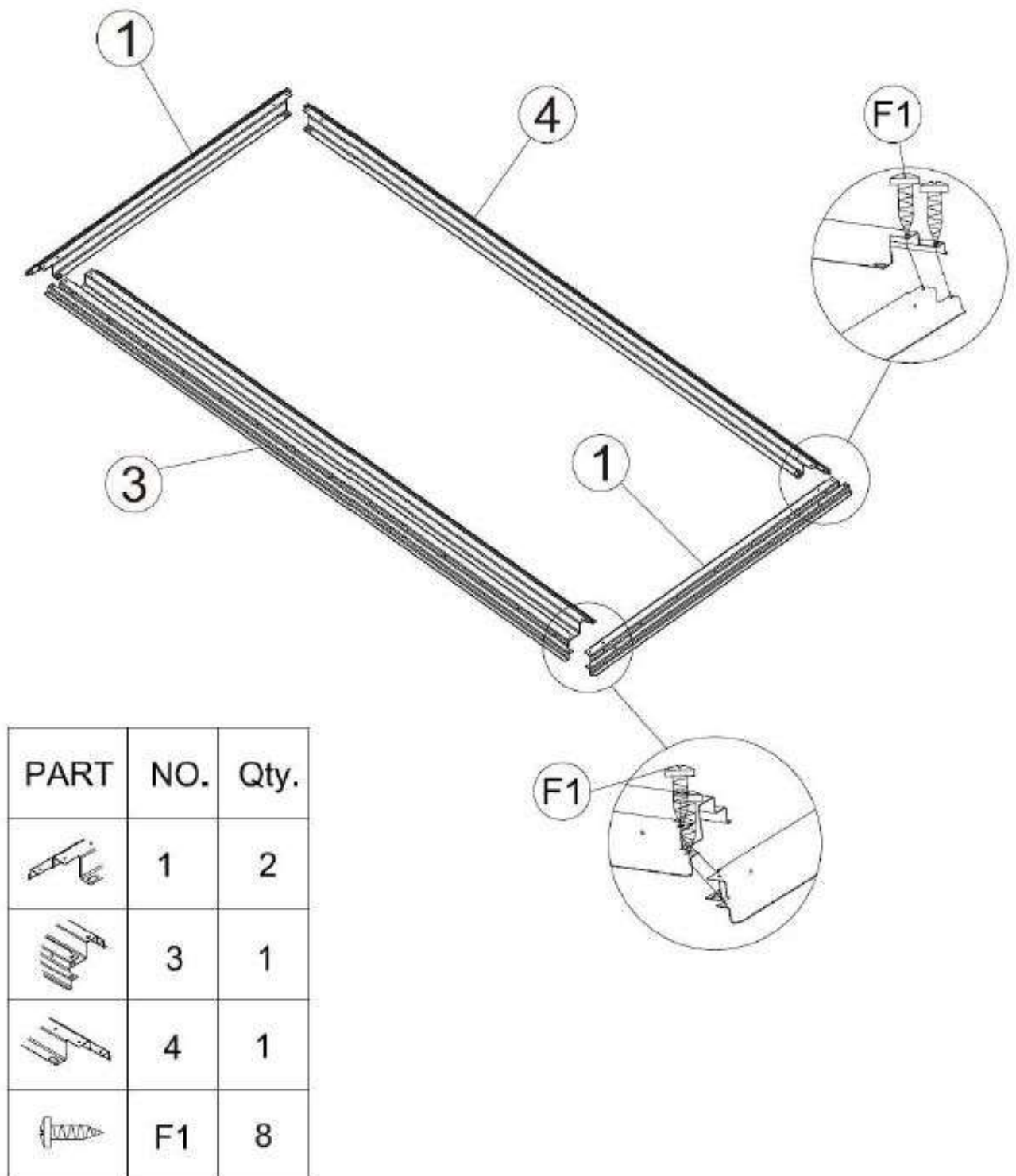

3-2 Krok 2



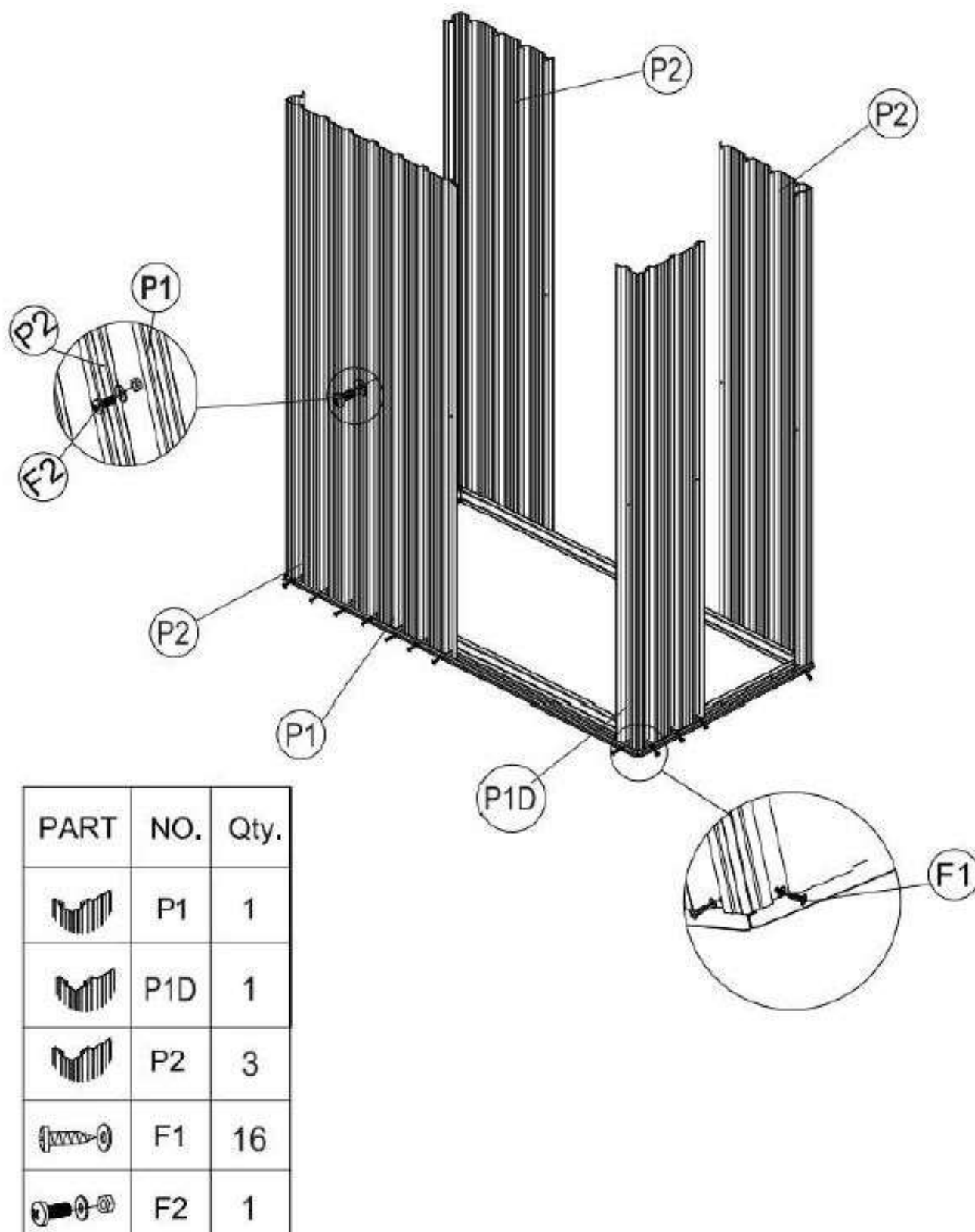

Vložte stenové panely (P1) (P1D) (P2) bočných stien do základových líšt (1)(2)(3)(4) domčeka, nastavte otvory a upevnite stenové panely (P1) (P2) v strede skrutkami (F2).

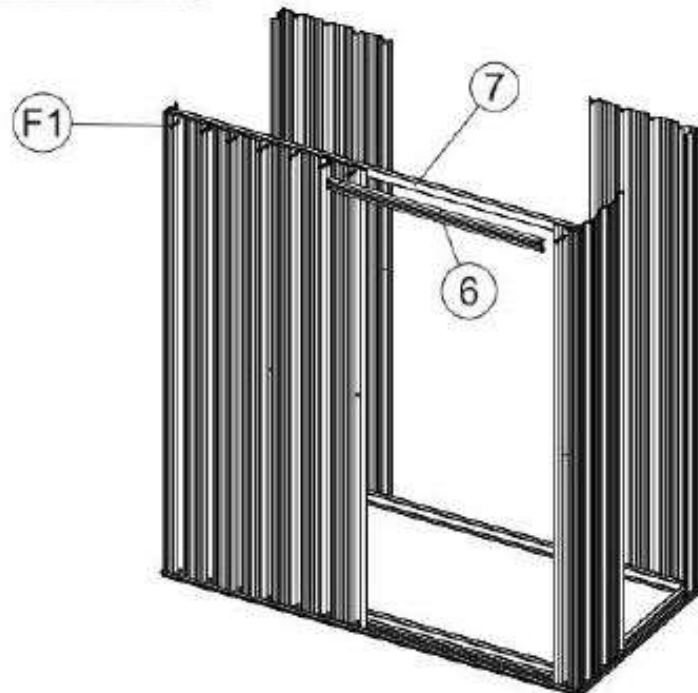
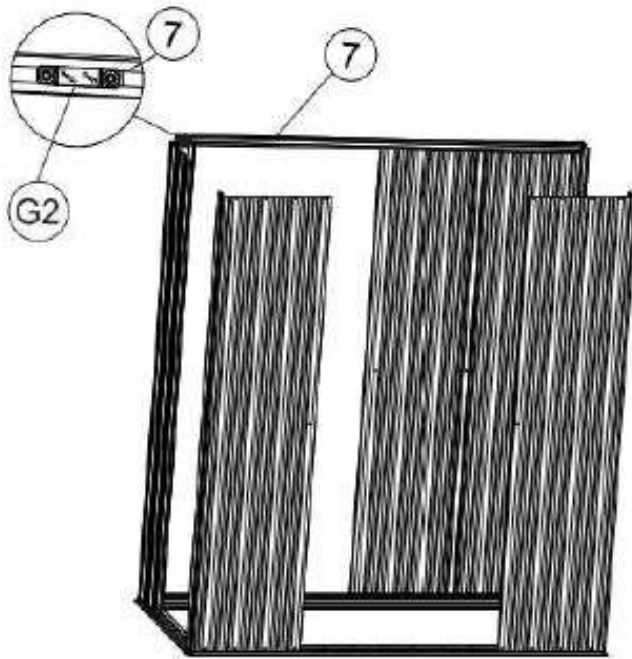

3-3 Krok 3

- Vložte dva bloky koliesok (G2) do hliníkovej koľajničky (7) (pozri detail) a upevnite ich napr. lepiacou páskou.
- Koľajničku dverí (6) namontujte medzi predné steny P1 a P1D (pozri 3-2). Slúži pre vedenie dverí a udáva neskoršiu šírku dverí.
- Koľajničku (7) vložte zvnútra na prednú stenu, upevnite ju medzi koľajničku dverí (6). Nastavte otvory.
- Pre upevnenie použite skrutky (F1) a podložky (pozri náčrt nižšie).
- **Poznámka:** Koľajnička (7) nemá predvŕtané otvory pre skrutky. Hliník je mäkký materiál, do ktorého je možné skrutky pri miernom prítlaku zaskrutkovať.







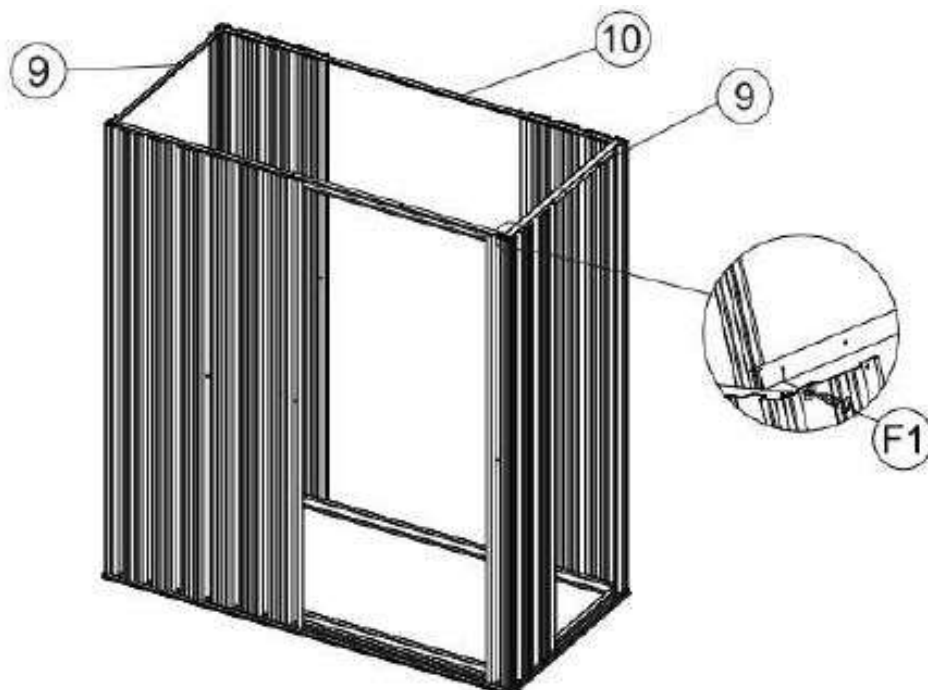

PART	NO.	Qty.
	6	1
	7	1
	G2	2
	F1	8

3-4 Krok 4

Horné uholníky (9) (10) položte na horné lišty stien, nastavte otvory a upevnite ich skrutkami (F1). Stenové panely (P1A) (P3) (P4B) potom vložte do základovej lišty (1) (4), nastavte otvory a upevnite zvonku ich skrutkami (F1) a podložkami.





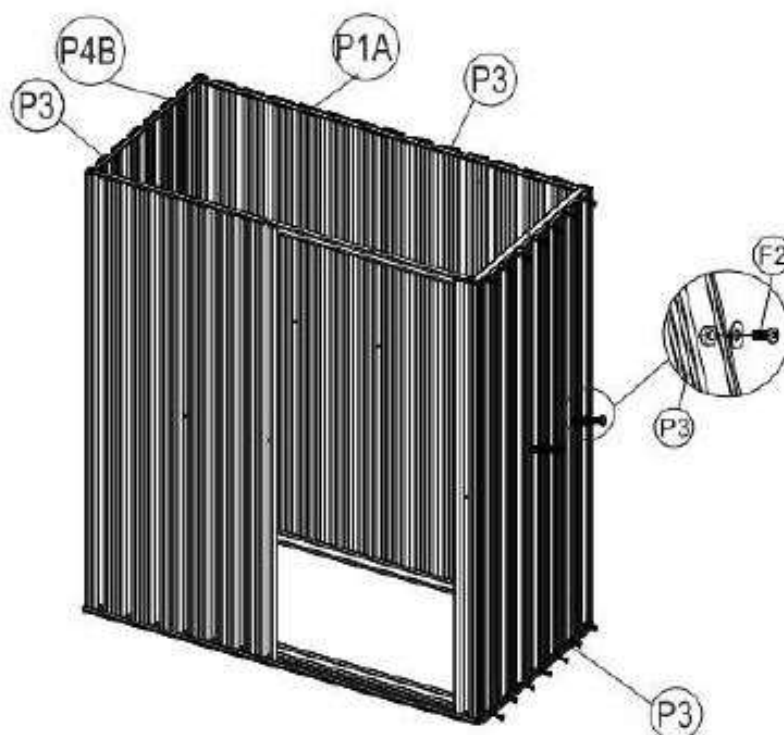

PART	NO.	Qty.
	9	2
	10	1
	P1A	1
	P3	3
	P4B	1
	F1	48
	F2	8

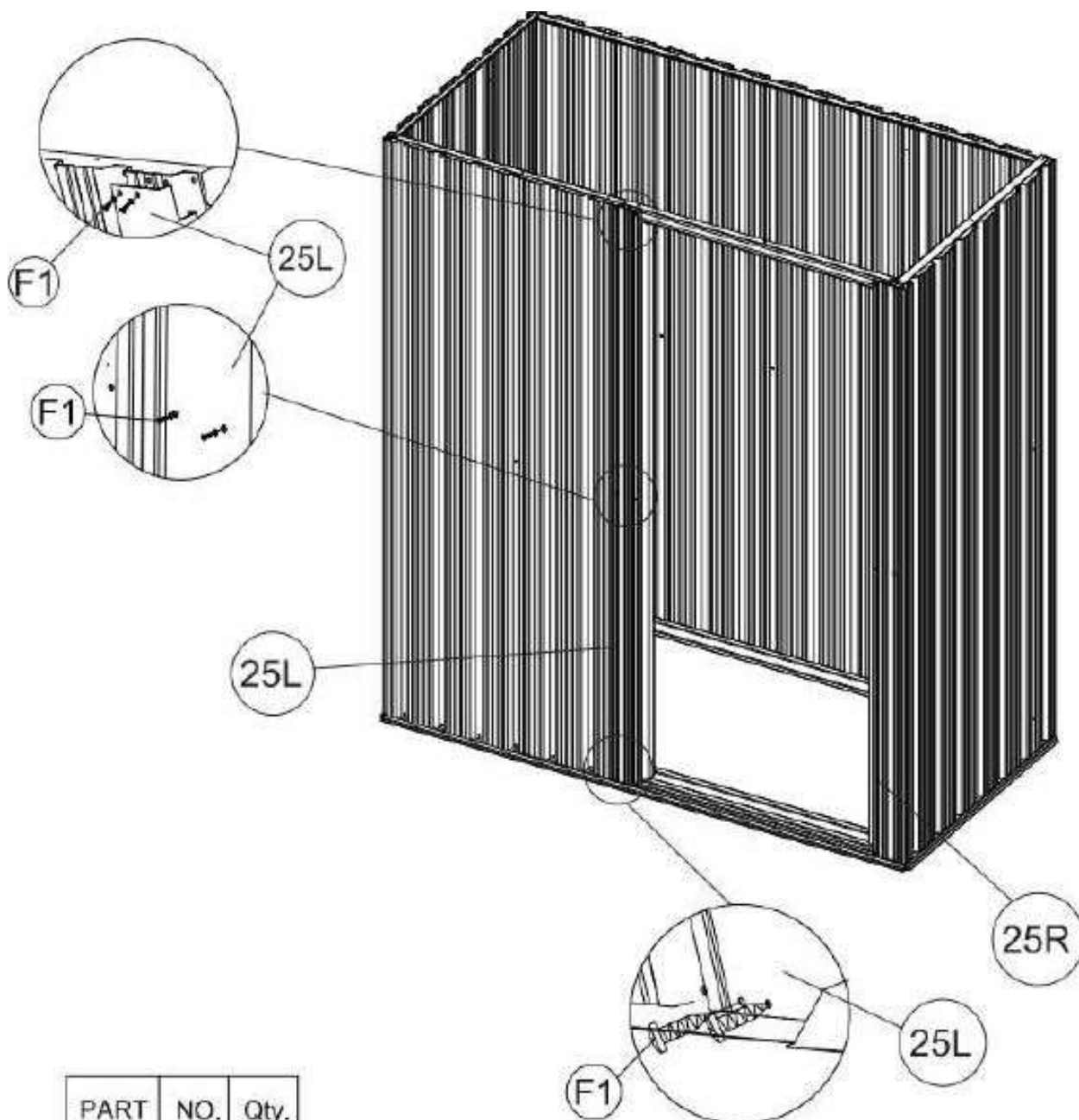

3-5 Krok 5

Stĺp dverí (25L) položte na základovú lištu (3) a zasunúte ho do panela steny. Potom zaistíte stĺp dverí (25L) skrutkami (F1). Postup opakujte pre pravý stĺp dverí (25R).





PART	NO.	Qty.
	25L	1
	25R	1
	F1	12

3-6 Krok 6

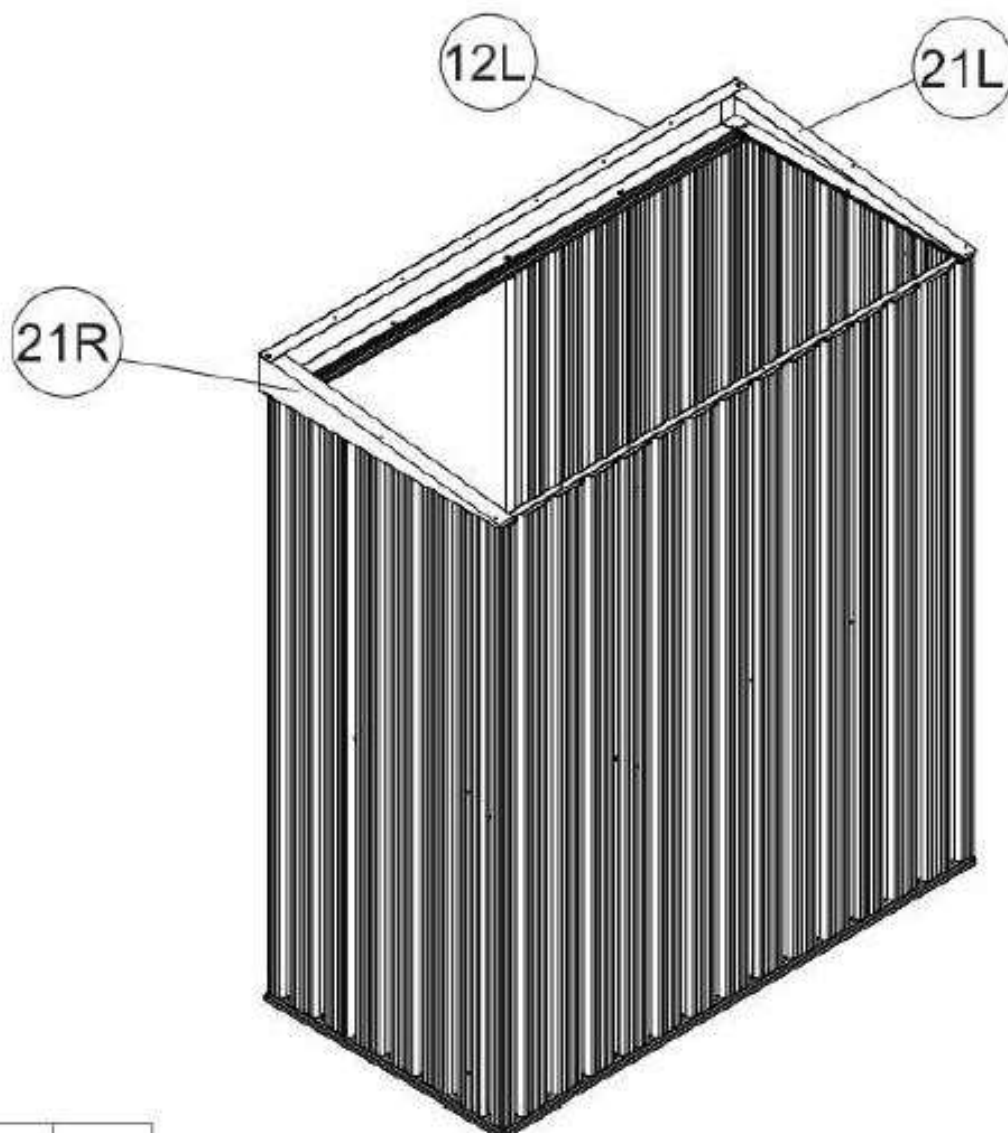
Upevníte kvadratický panel (12L) a štítové panely (21L) (21R) skrutkami (F1) zvnútra o hornú stranu kanála dverí (6) a o bočné horné lišty (9).

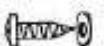

PART	NO.	Qty.
	12L	1
	21L	1
	21R	1
	F1	10



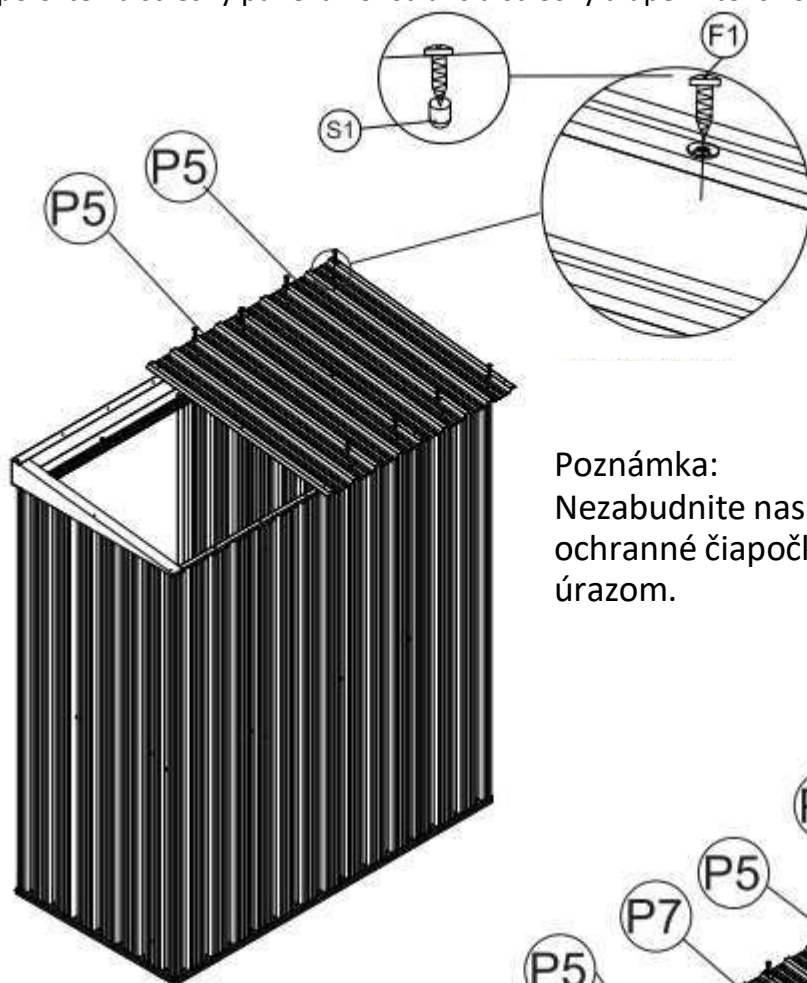

3-7 Krok 7

Strešné panely (P5) (P7) položte na strešný panel a konštrukciu strechy a upevnite ich skrutkami (F1) a podložkami.

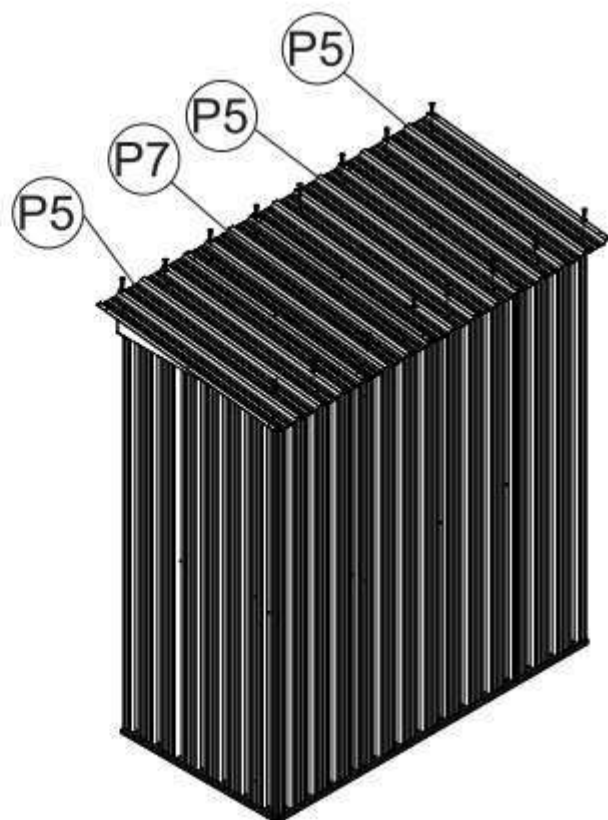

Poznámka:
Nezabudnite nasadiť na skrutky F1 ochranné čiapočky A1, aby sa predišlo úrazom.

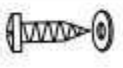



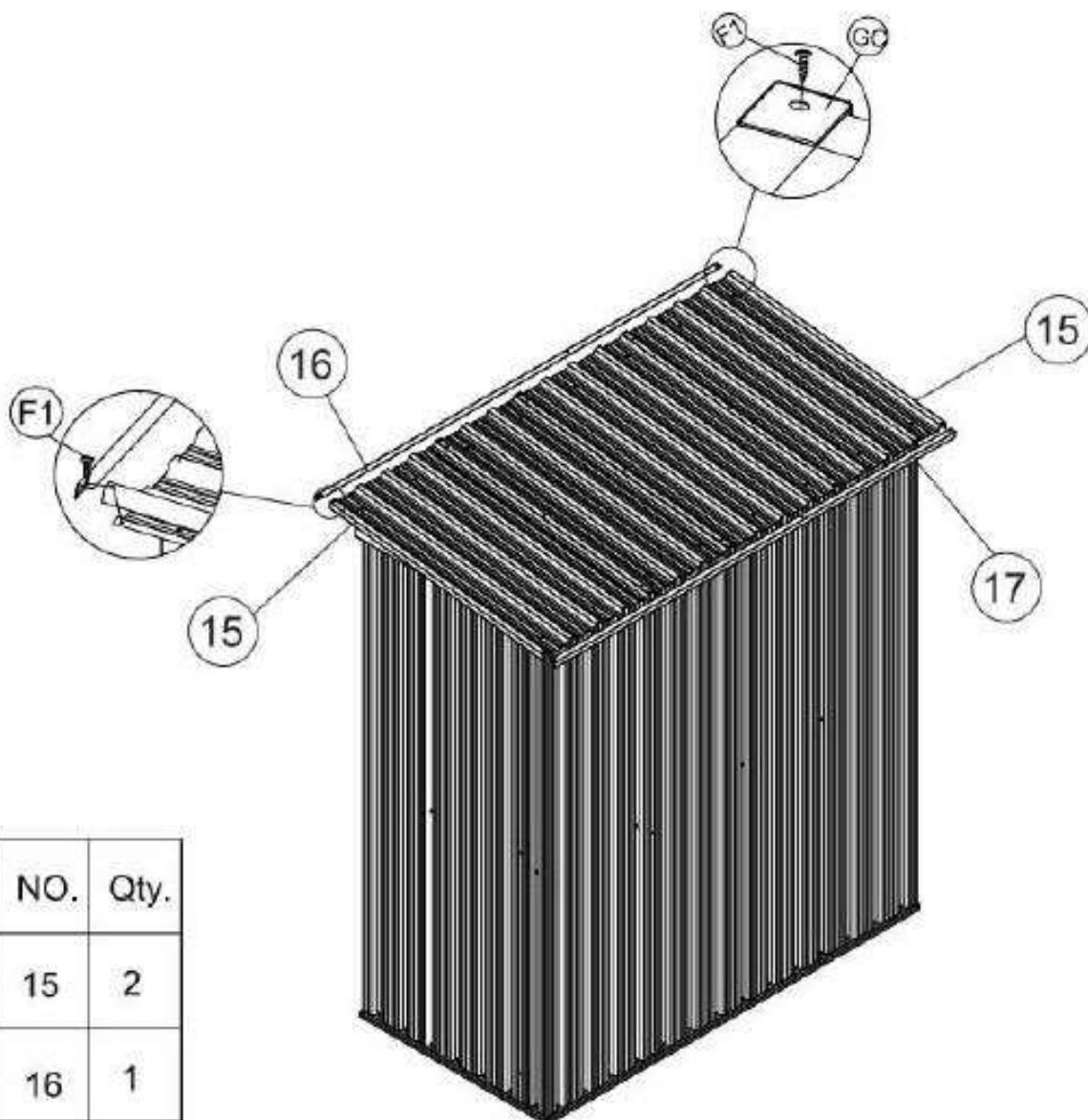

PART	NO.	Qty.
	P5	3
	P7	1
	F1	32
	S1	122

3-8 Krok 8

Namontujte strešné lišty (15) (16) (17) na strešné dosky. Upevnite ich skrutkami (F1) a podložkami. Potom nasadte 4 rohové koncovky (GC) a upevnite ich skrutkami a podložkami.





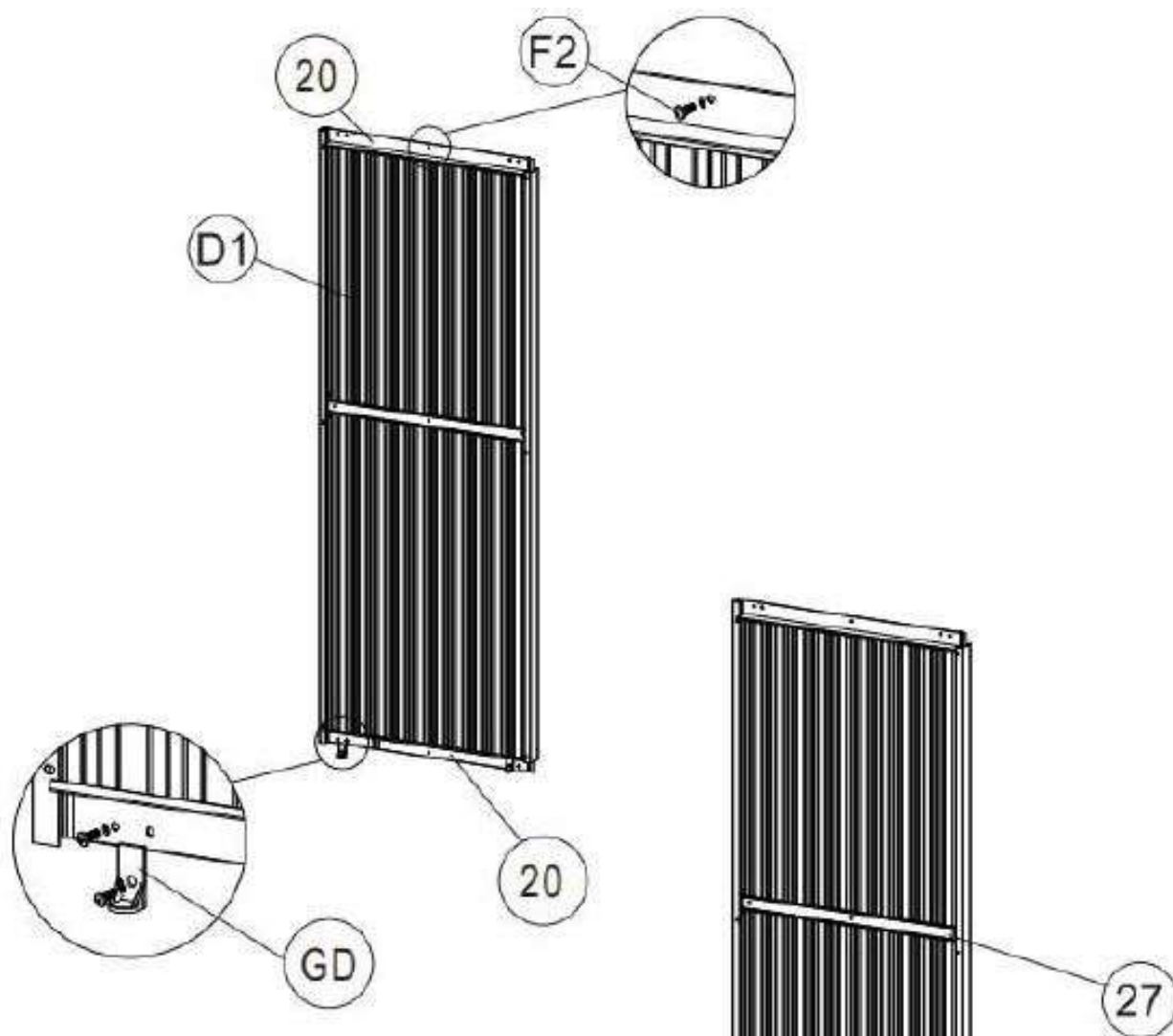

PART	NO.	Qty.
	15	2
	16	1
	17	1
	GC	4
	F1	8

3-9 Krok 9

Na hornú stranu výplne dverí (D1) namontujte lištu (20) pomocou skrutiek (F2), matíc a podložiek. Potom namontujte druhú lištu (20) pomocou skrutiek (F2), matíc a podložiek na výplň dverí (D1). Lištu (27) namontujte pomocou skrutiek (F2), matíc a podložiek do stredu výplne dverí (D1).





PART	NO.	Qty.
	27	1
	20	2
	D1	1
	GD	2
	F2	8

3-10 Krok 10

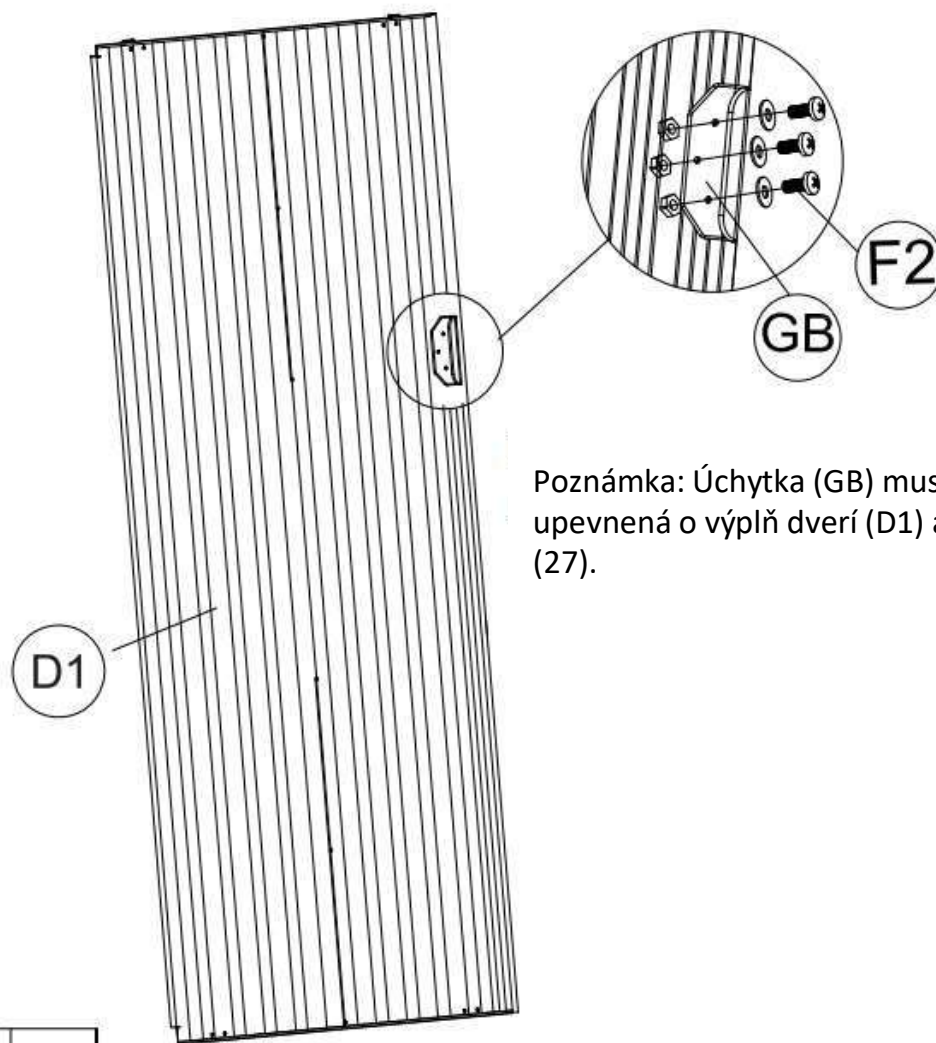
Úchytka (GB) upevníte na výplň dveří (D1) zvnútra skrutkami (F2) a maticami.





Poznámka: Úchytka (GB) musí být upevnená o výplň dveří (D1) aj o tyč dveří (27).

PART	NO.	Qty.
	GB	1
	F2	3

3-11 Krok 11

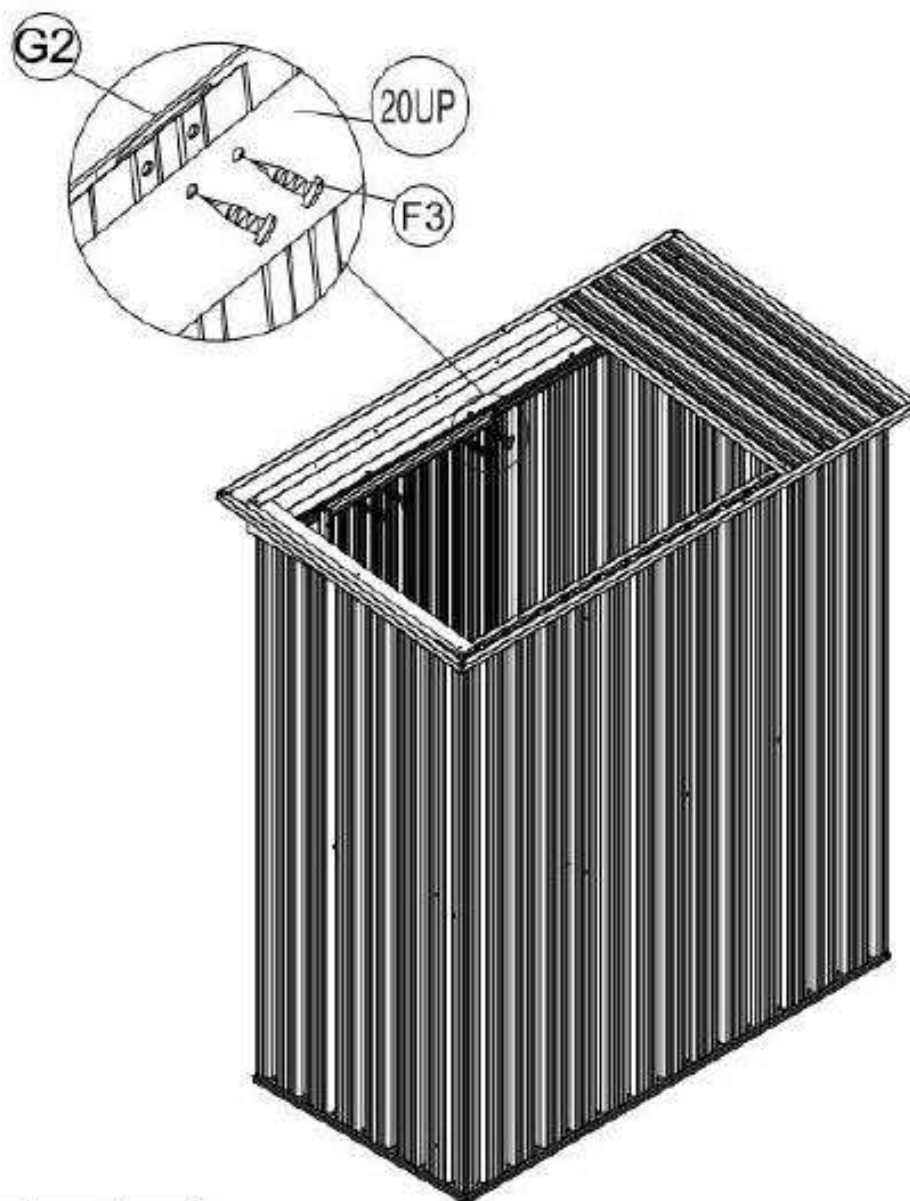
Zasuňte uzol výplne dverí (D1) do základovej lišty (3), a potom upevnite hornú časť dverí skrutkami (F3) o horný posúvač (G2). Pozri náčrt nižšie.













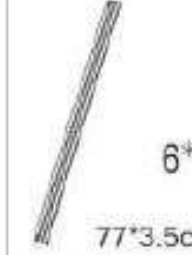

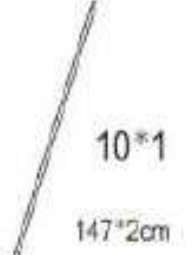

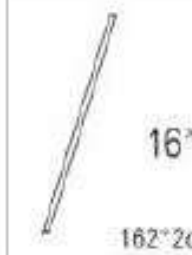
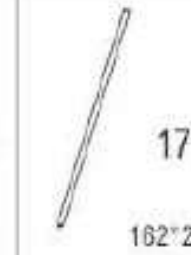

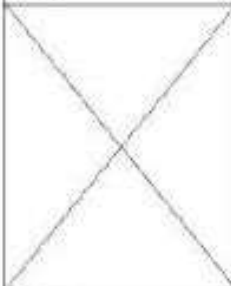
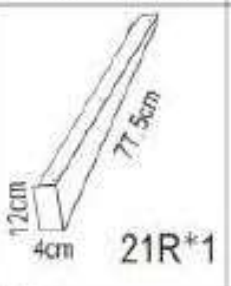

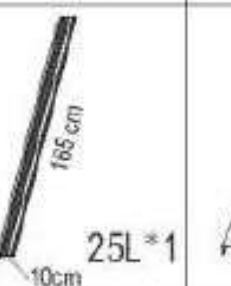

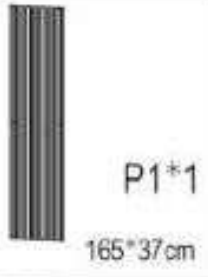



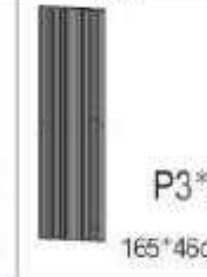
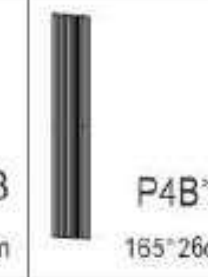
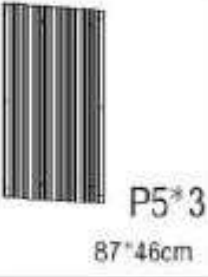

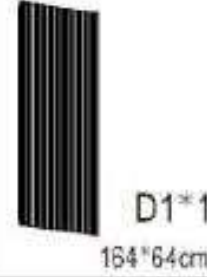
PART	NO.	Qty.
	F3	4

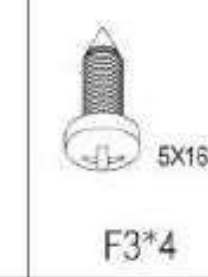
4 Údržba

- Pravidelne čistite strechu od lístia, nečistôt a cudzích elementov.
- Vodiace koľajničky pravidelne ošetrujte napr. silikónovým sprejom.
- Pravidelne kontrolujte skrutkové spoje.
- Domček čistite jemným roztokom saponátu vo vode, nepoužívajte žiadne agresívne čistiace prostriedky ani rozpúšťadlá.

5 Zoznam dielov

 <p>NR 1*2 STK 1*2 75*6cm</p>	 <p>3*1 150*13cm</p>	 <p>4*1 150*6cm</p>	 <p>6*1 77*3.5cm</p>	 <p>7*1 147*3cm</p>	 <p>9*2 72.5*2cm</p>
 <p>10*1 147*2cm</p>	 <p>12L*1 152*12*4.7cm</p>	 <p>15*2 87*2cm</p>	 <p>16*1 162*2cm</p>	 <p>17*1 162*2cm</p>	 <p>59cm 3.2cm 27cm 20*2</p>
	 <p>12cm 4cm 7T 5cm 21R*1</p>	 <p>12cm 4cm 7T 5cm 21L*1</p>	 <p>2.5cm 10cm 165cm 25R*1</p>	 <p>2.5cm 10cm 165cm 25L*1</p>	 <p>27*1 62.5*2cm</p>
 <p>P1*1 165*37cm</p>	 <p>P1A*1 165*37cm</p>	 <p>P1D*1 165*28cm</p>	 <p>P2*3 165*38.5*7cm</p>	 <p>P3*3 165*46cm</p>	 <p>P4B*1 165*26cm</p>
 <p>P5*3 87*46cm</p>	 <p>P7*1 87*37cm</p>	 <p>D1*1 164*64cm</p>	 <p>4X10 F1*142</p>	 <p>M4X10 F2*20</p>	 <p>5X16 F3*4</p>
 <p>0.7X1CM S1*122</p>	 <p>9X2CM G2*2</p>	 <p>11.8X3.8cm GB*1</p>	 <p>3X3cm GC*4</p>	 <p>3.6X1.8cm GD*2</p>	 <p>6X4.7cm *14</p>